

Name _____

Trace the letters and practice printing them. Color the pictures.

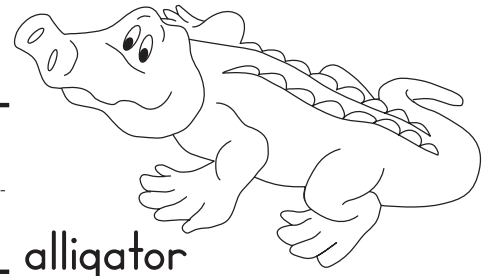

alligator

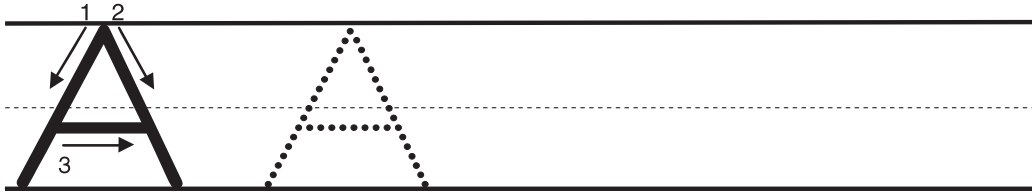
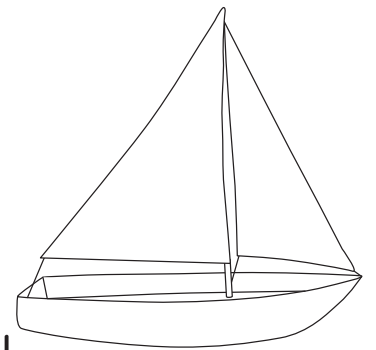
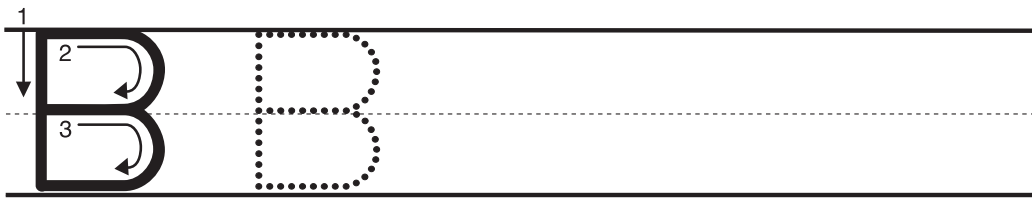

boat

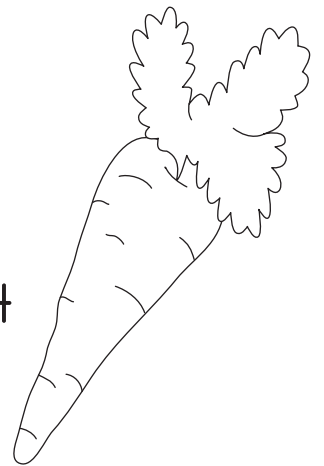

carrot

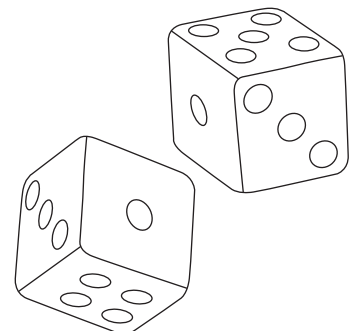
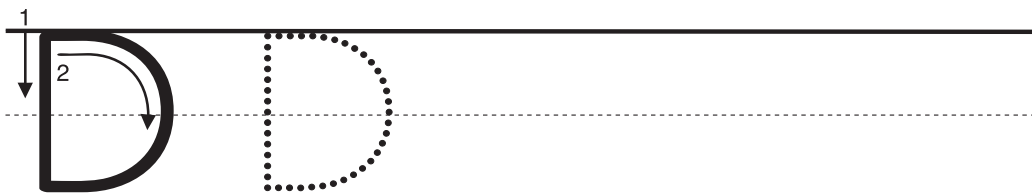

dice

Name _____

Trace the letters and practice printing them. Color the pictures.

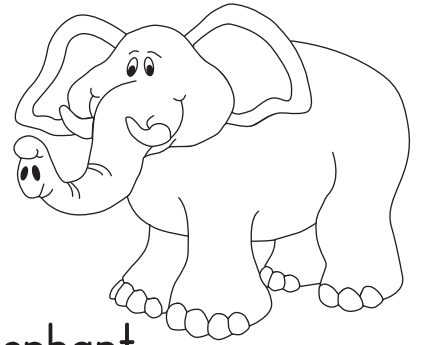
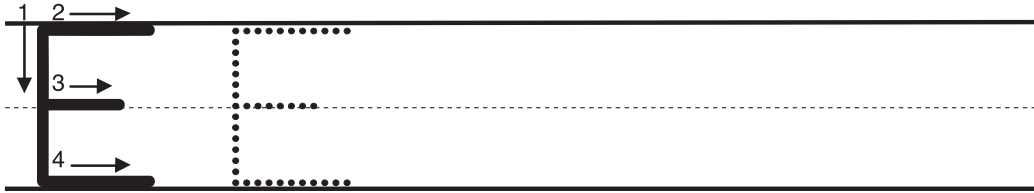

elephant

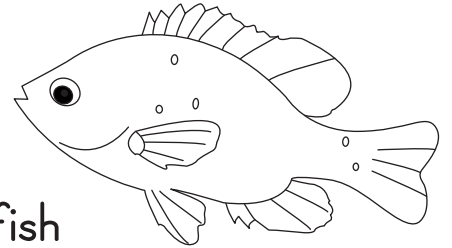
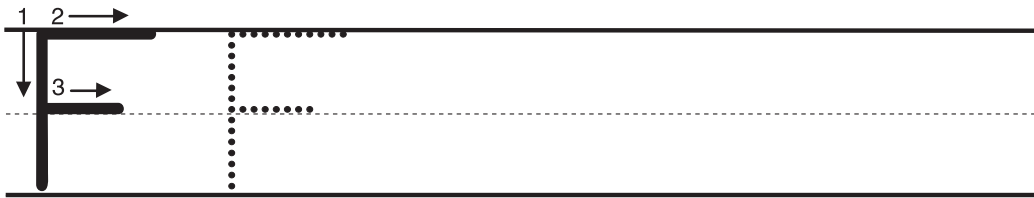

fish

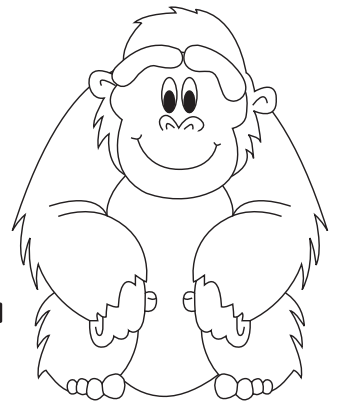

gorilla



house

Name _____

Identify and color the items.

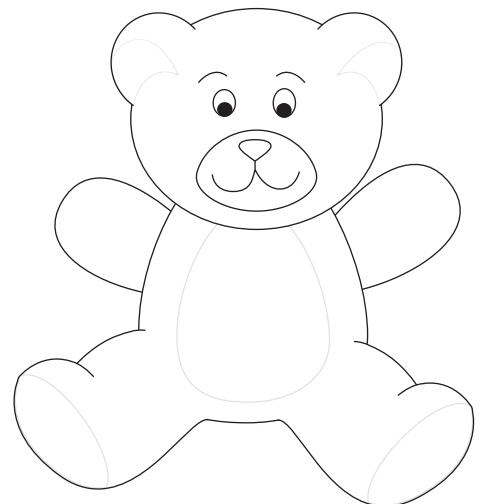
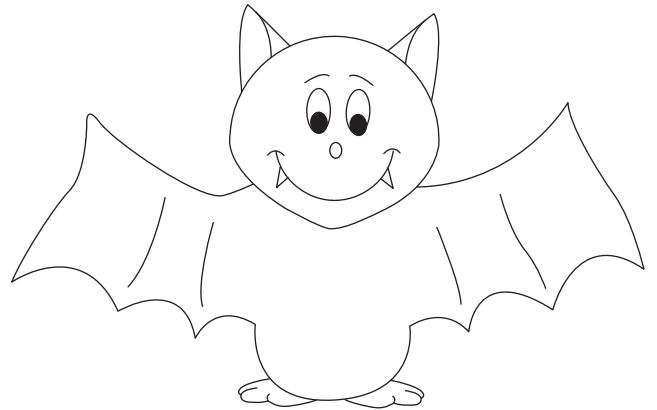
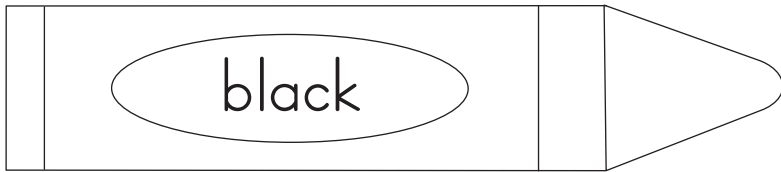
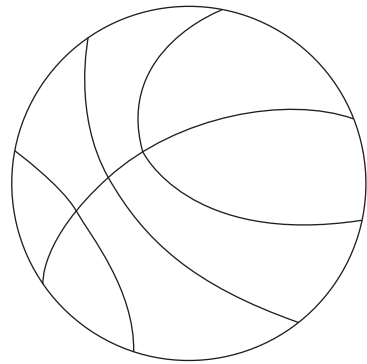
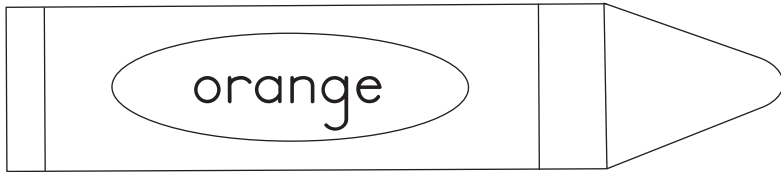
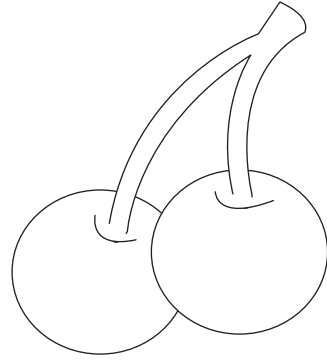
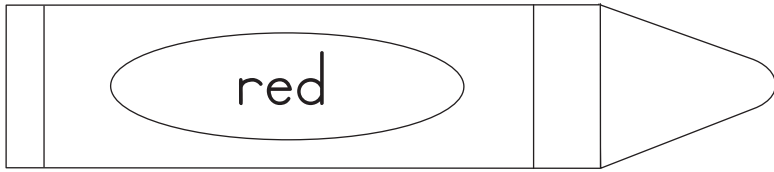





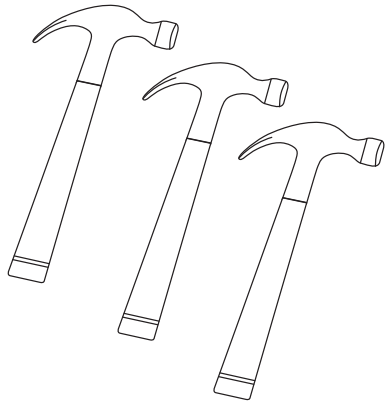
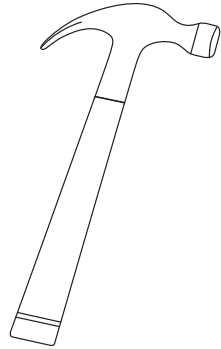
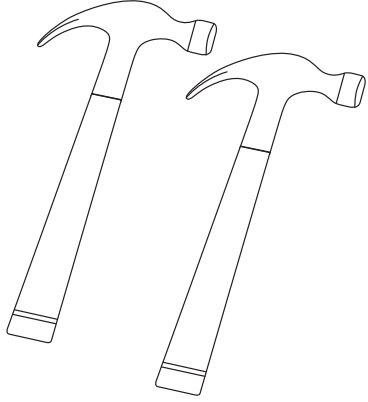
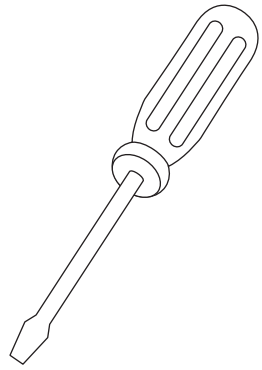
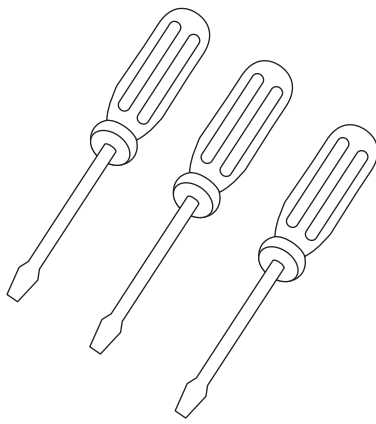
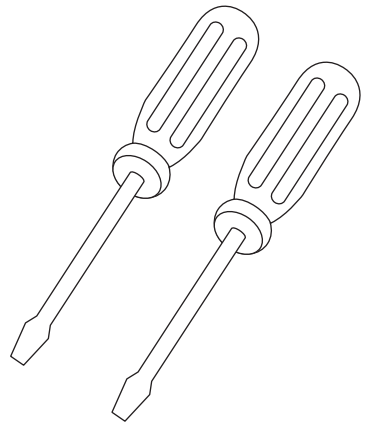
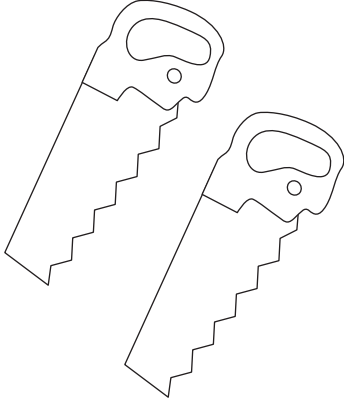
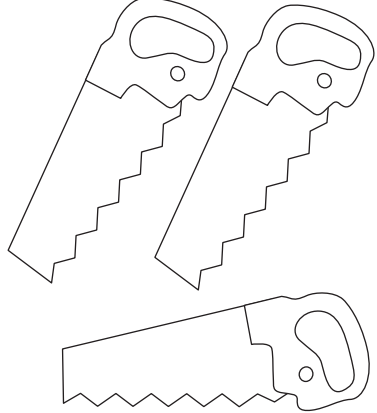
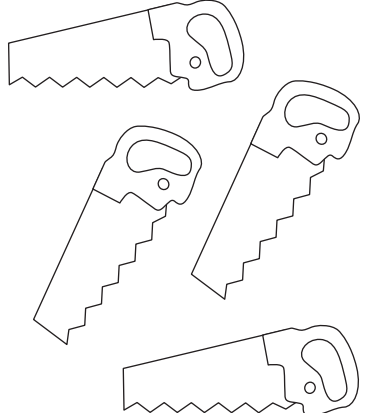
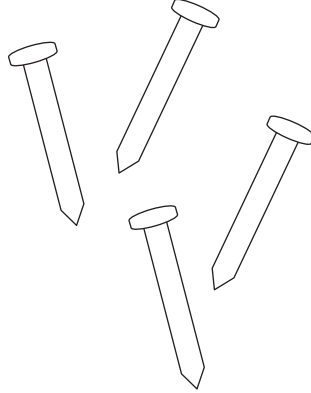
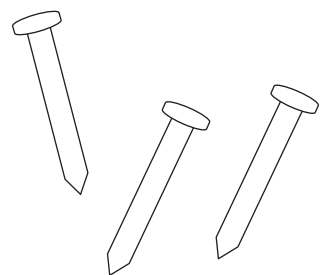
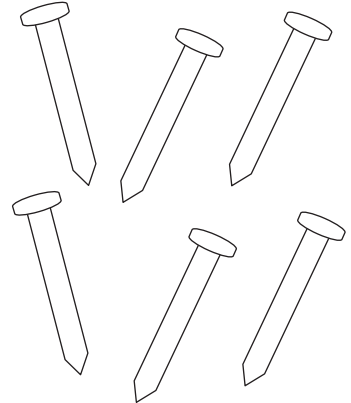

Name _____

Color the numeral. Color the items in the box that matches the number.

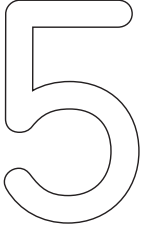
1			
2			
3			
4			

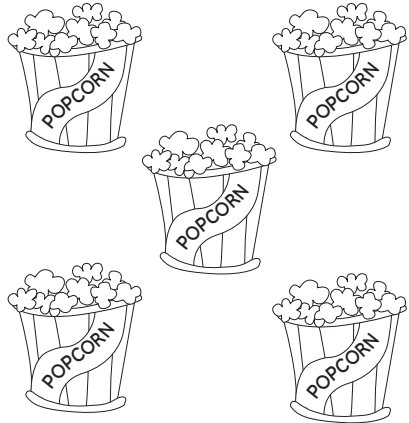
Name _____

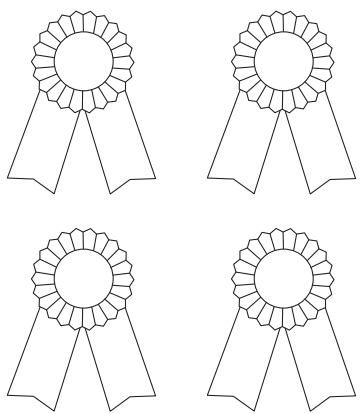
Color the numeral. Color the items in the box that matches the number.

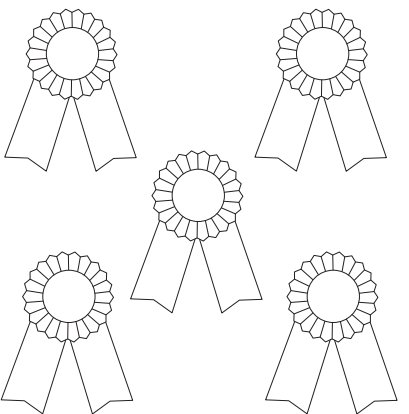
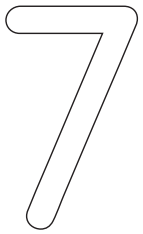
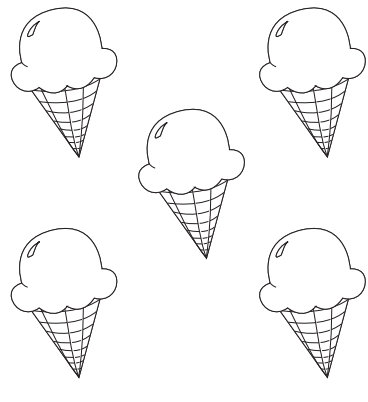
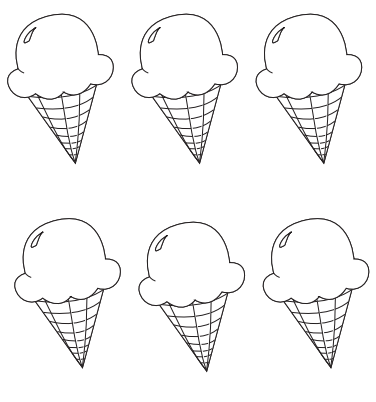
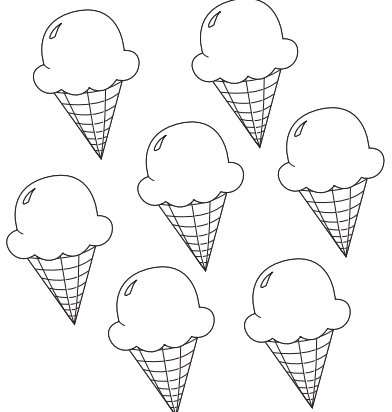
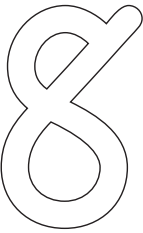
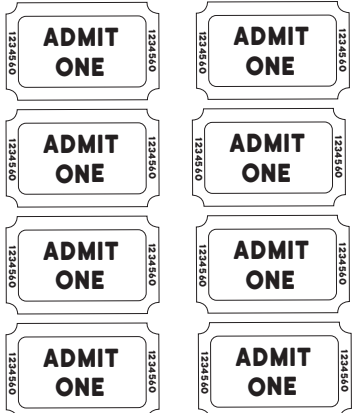
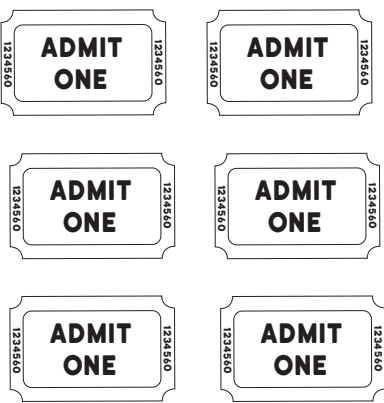
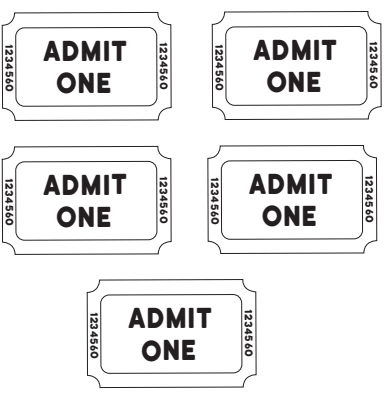
Name _____

Trace the paths with a crayon. Color the pictures.

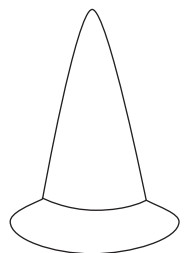
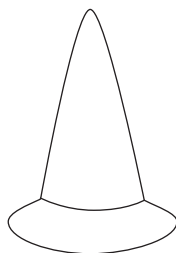
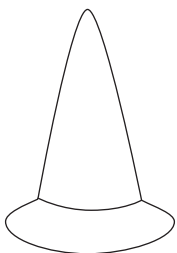
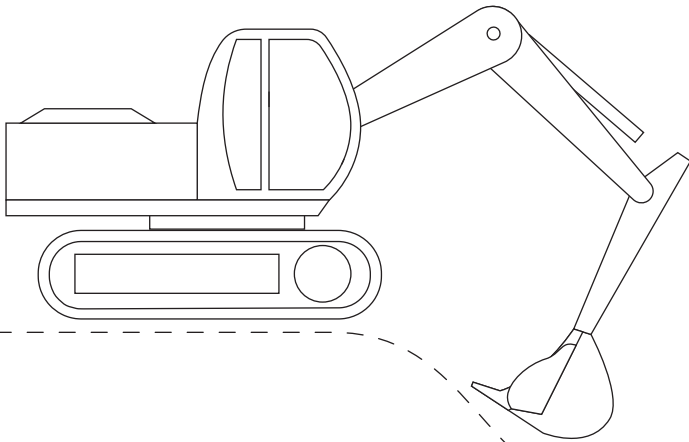
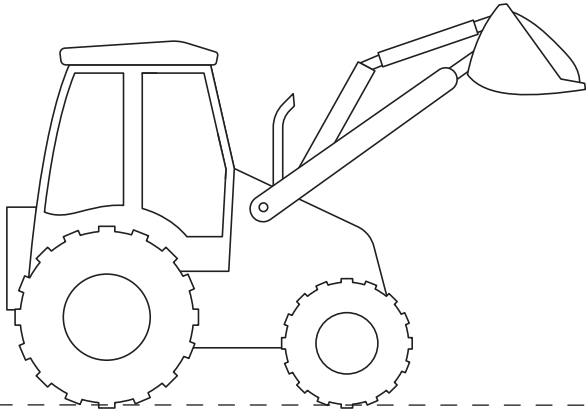
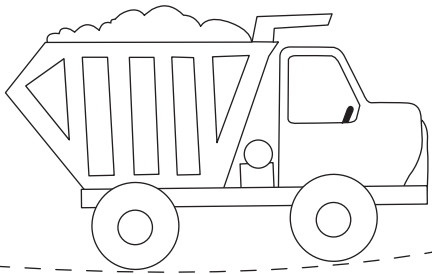

Name _____

Color the shapes.

Place an X over the shapes that are NOT circles, triangles, or rectangles.

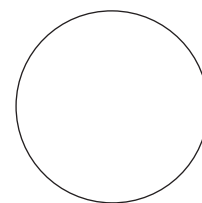
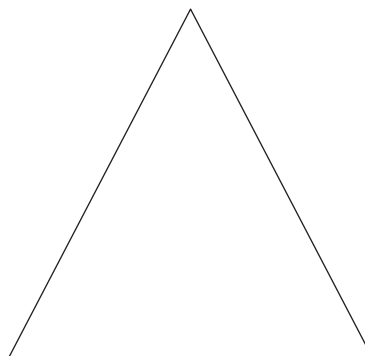
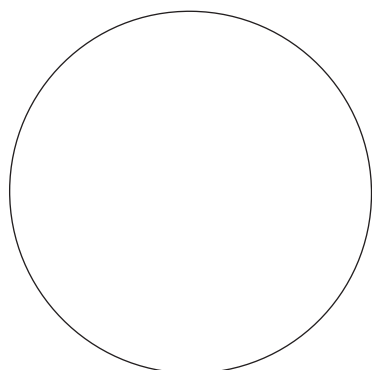
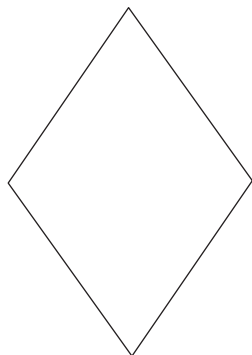
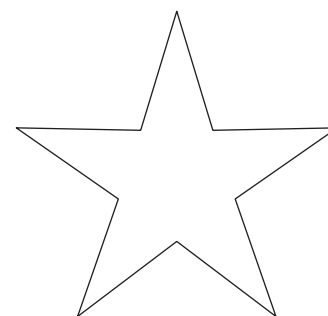
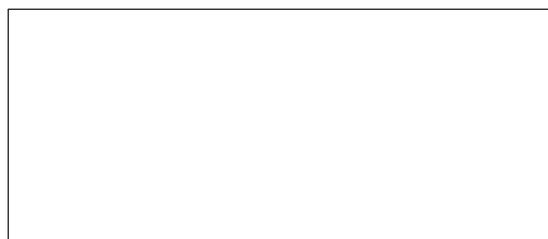
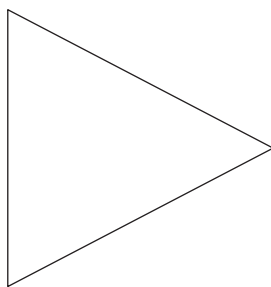
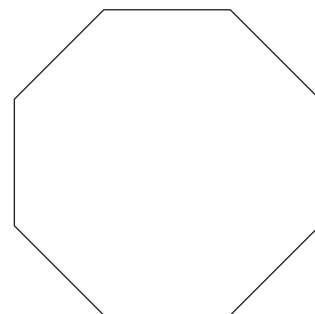
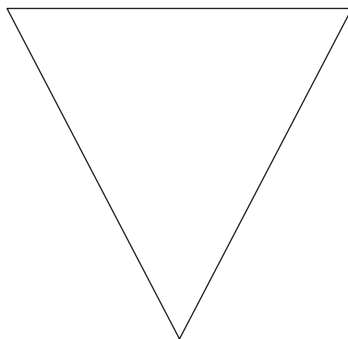
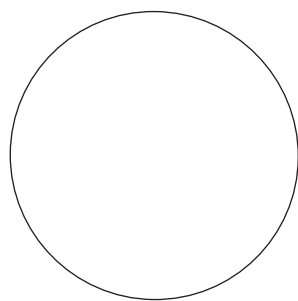
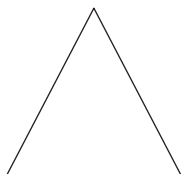
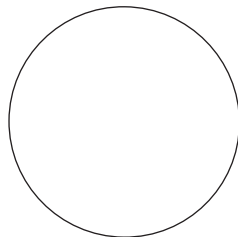
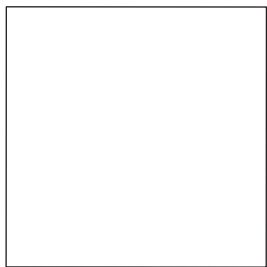

Name _____

Color the pictures. Cut out the cards and place the children on the ferris wheel.

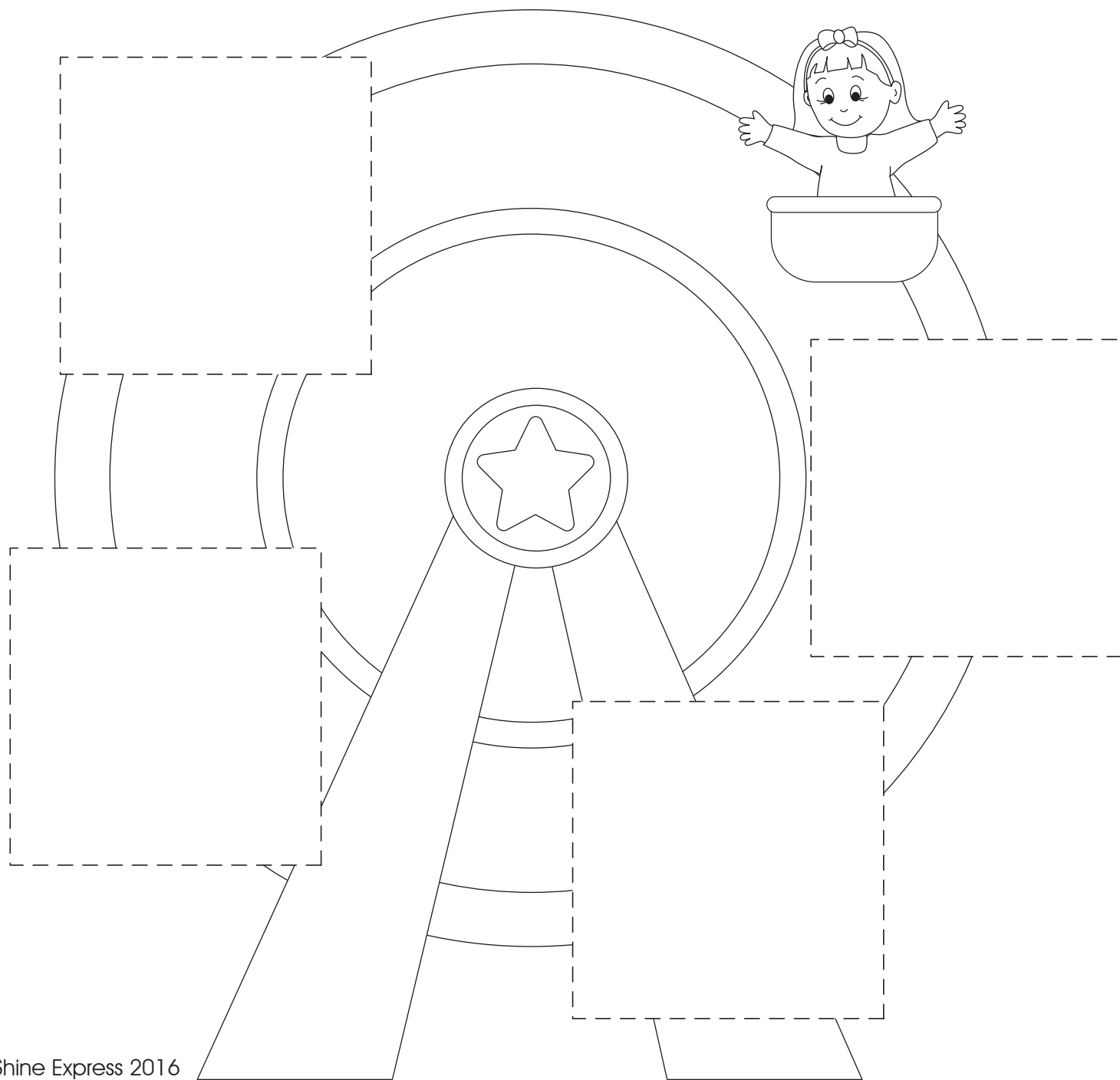

©FunShine Express 2016

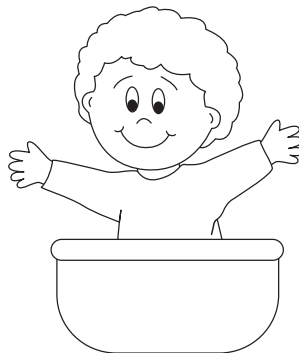
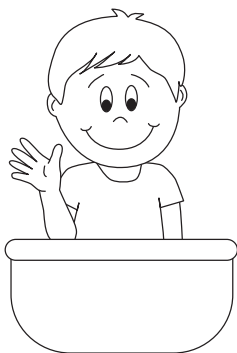

Name _____

Print the correct letter on each line to complete the words. Color the pictures.

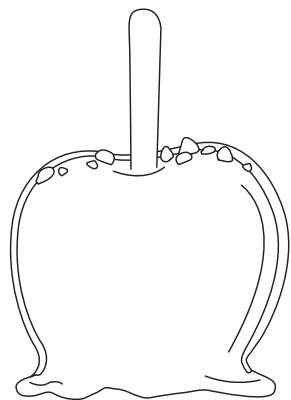

__ pple

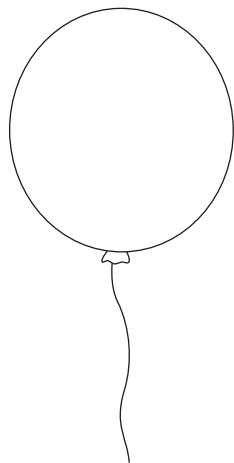

__ alloon



__ otton candy

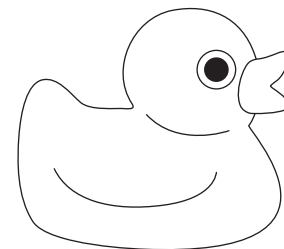

__ uck



__ at

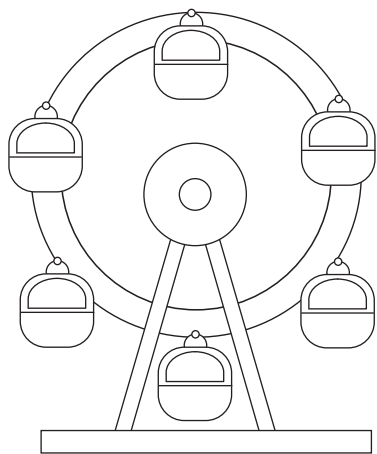

__ erris wheel

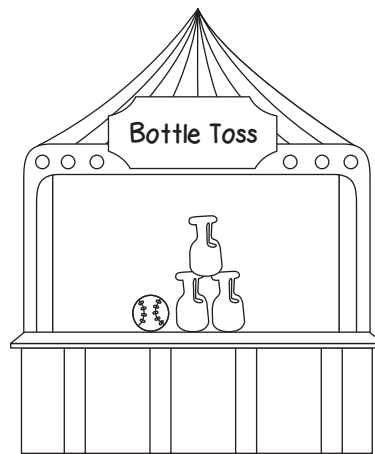

__ ame

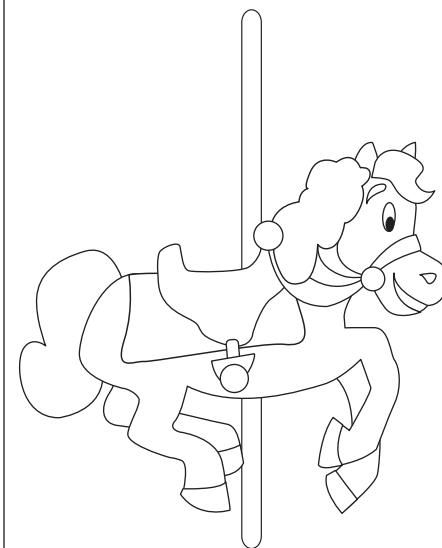

__ orse